

musser

A DIVISION OF THE CONN-SELMER, INC.

Dear Customer,

We at Musser want to thank you for selecting one of our percussion instruments. Generations of **American Craftsmanship**, Knowledge and Pride go into each and every **Musser** product.

In striving to offer the highest quality instruments and service in meeting your musical needs, we ask that you please complete both the registration Form and our Customer Satisfaction Survey.

If you are pleased, **tell everyone**; if you are not, **please let us know**.
WE WANT TO KNOW!

Specifications are subject to change without notice as we at Musser continue to improve our products. The information in this manual is intended to be of a general nature only.

Thank you,

All Employees

Musser Division
Conn-Selmer Inc.



SPECIFICATIONS FOR MUSSER "ONE NIGHTER ALL TERRAIN"

MODEL NUMBER: M8046 **NAME:** "ONE NIGHTER ALL TERRAIN"

KEYBOARD SPECIFICATIONS: **RANGE:** 3 Octaves - 37 Notes – F3 TO F6
Adjustable height Keyboard from 32" to 39" tall.

BAR SIZES: Length of lowest note 14-3/8" graduating down to 6-15/16" highest note.

<u>WIDTH AND THICKNESS:</u>	F3 to C4	2-1/4" wide by	1/2" thick
	C4# to F4	2" wide by	1/2" thick
	F4# to F5	1-3/4" wide by	1/2" thick
	F5# to F6	1-1/2" wide by	1/2" thick

PITCH: Bars tuned to A-442 Pitch

MATERIAL: Aluminum.

FINISH: Ball Burnished.

RESONATOR SPECIFICATIONS:

MATERIAL: High grade light aluminum alloy tubing.

FINISH: Scratch resistant silver vein powder coating.

CONSTRUCTION: Braces are 1/8" steel fastened with rivets to aluminum resonators.

END FRAMES: The frame is made of selected hardwood and painted to a black Plextone finish. The cart frame is made of rugged 1-1/4" square steel tube and is attached by a steel crossbar support. Wheels are Industrial pneumatic 10" casters, two low end stationary wheels and two swivel wheels with brakes. Size: High End, 17-3/8" w, Low End, 30-3/4" w, x 32 to 39" tall x 56-1/2" long. Total weight is 100 lbs.

***NOTE: FOR THE M8046 REFER TO THE ENCLOSED INSTRUCTIONS FOR ASSEMBLING THAT PARTICULAR CART.**

ASSEMBLY INSTRUCTIONS FOR THE M-7046 "ONE NIGHTER" VIBRAPHONE AND MOTO CART

PARTS LIST

Moto Cart Frame

1 set of Resonators (Natural and Sharp Scale)

1 set of Bars (Natural and Sharp Scale)

Crossbar and Pedal Assembly

Read all instructions carefully before assembling the instrument.

- 1.** Place wide end piece (decal side down) on a flat, smooth surface. Install upper Crossbar with brace screws facing down. (See Illustration I) Retract the spring-loaded pin at one end of the crossbar. Slide the end of each crossbar into the sleeve attached to the end piece. Align the crossbar pin with the hole in the sleeve. Release the pin making certain that the pins are fully released through the hole in the sleeve. **(Note: one end of the lower crossbar has a small hole through one wall of the tube. This end must go into the wide end piece for proper damper pedal alignment.)** Place this end on the ground on its casters.
- 2.** Retract the spring-loaded pin at the free end of the crossbar. Guide the end of each crossbar into the proper sleeve on the narrow end piece. Align the pin with the hole in the sleeve and release it fully through the sleeve hole.
- 3.** Assemble the crossbar braces to the crossbar and end pieces as shown in Illustration I. Make certain the plastic knobs are securely tightened.

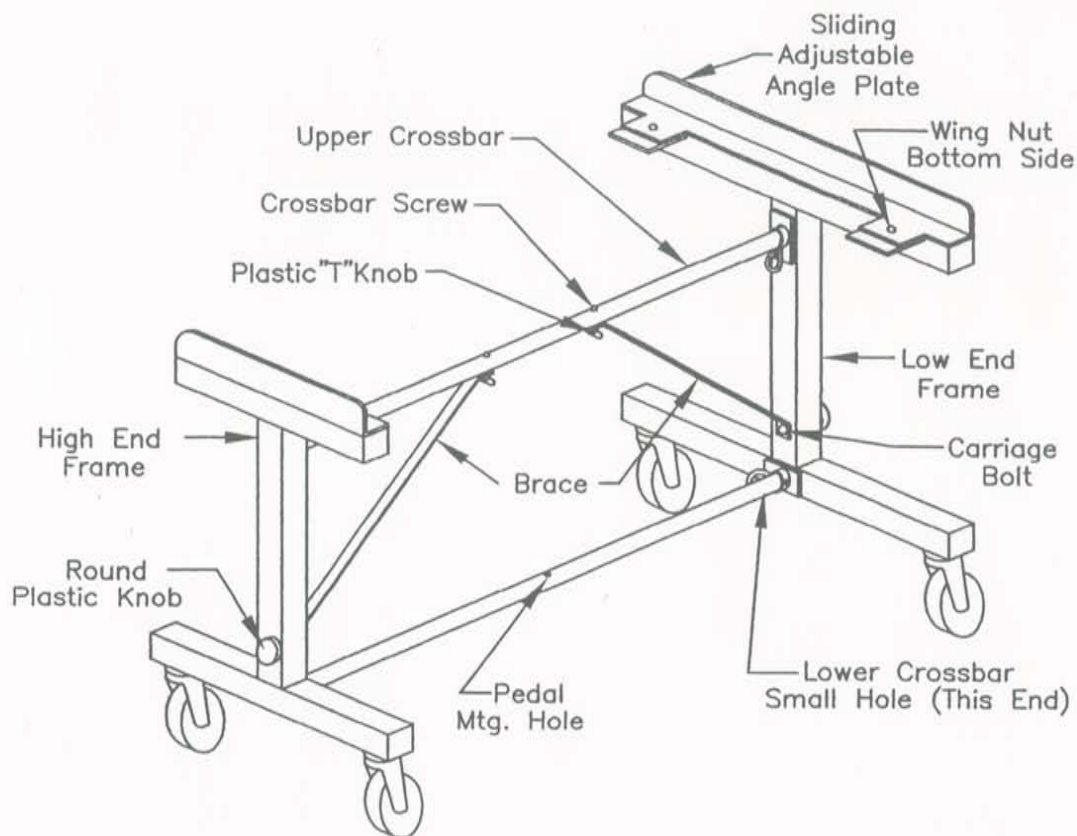

ILLUSTRATION I

4. Loosen the wing nuts on the sliding adjustable plate and slide it back away from the frame. Place the instrument frame on to the motocard. Push the frame toward the narrow end as far as it will go. Slide the adjustable angle plate against the frame and tighten the wing nuts securely. Make certain that the frame ends are aligned parallel to the cart end pieces.
5. Install the damper foot pedal into the center hole of the lower crossbar. Swivel the pedal so that it points toward the #1 rail (Players side). To attach the damper pedal to the damper bar, (see Illustration II), loosen the knob on the lower pull rod. Pull down spool "E" and hook the upper pull rod into the eyebolt on the damper bar.

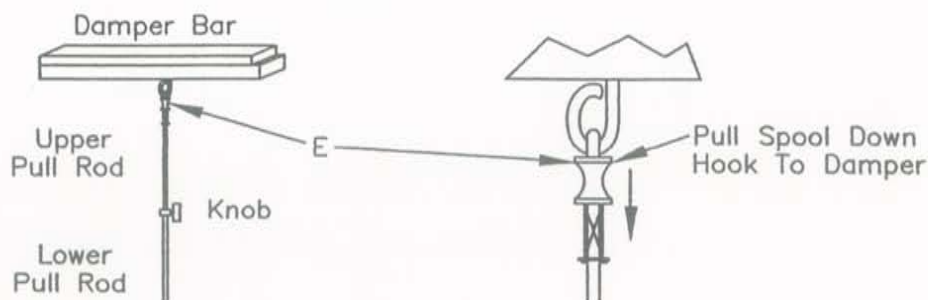

ILLUSTRATION II

6. Refer to Illustration III. Place the Natural Scale Resonator under the Frame. Slide the small end of the Resonator into the cutouts on the narrow Frame end. This end of the Resonator should rest inside the Frame End as shown in Illustration IV. Bring the other end of the Resonator up toward the Frame as shown in Illustration III. Refer to Illustration V and notice how one of the Resonator Strips passes between the two Rubber Resonator blocks and the other Strip passes between the Rubber Block and the #1 Rail. Center the Strips over the Slots in the Blocks and press them into place. Make certain, when the Resonator Strips are placed in the Slots of the Rubber Blocks, the Resonator is pulled back toward the wide end of the Frame as far as it will go as indicated by Arrow "F". Repeat the same procedure to install the Sharp Scale Resonator.

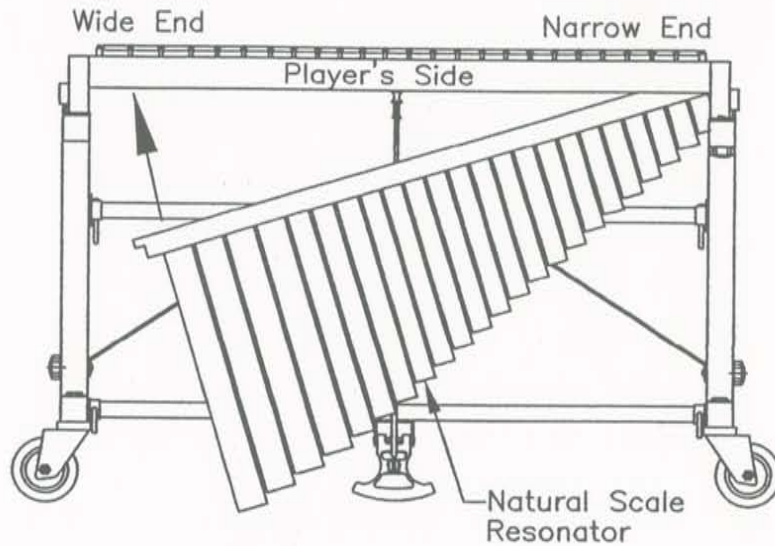

ILLUSTRATION III

Narrow End of Instrument

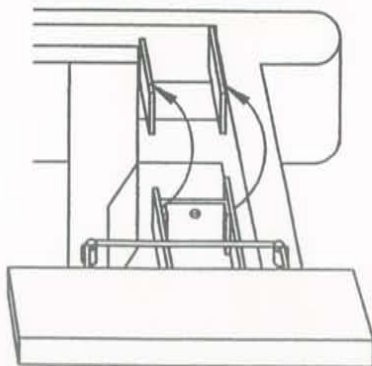

ILLUSTRATION IV

Wide End of Instrument

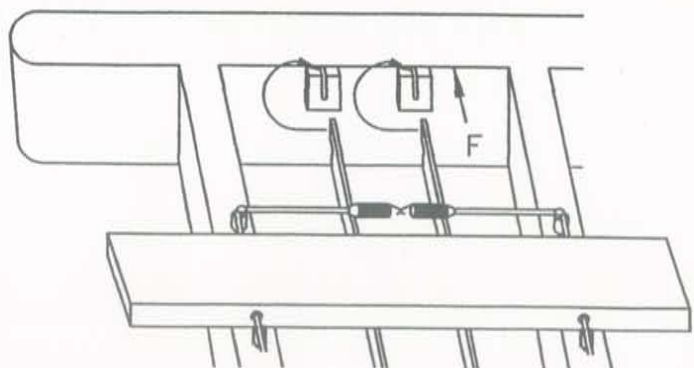

ILLUSTRATION V

7. Refer to Illustration VI. To install the Rubber Drive Belt (located at the narrow end of the instrument): (a) Slip the Drive Belt around the Pulley on the Motor. (b) Slip the Belt around one of the Resonator Pulleys. (c) Stretch the Belt by hand and slip it around the other Resonator pulley. Pull the belt by hand to insure it is correctly hooked onto the Resonator Pulleys. Try to align the Pulsators evenly by holding onto one pulley while rotating the other.

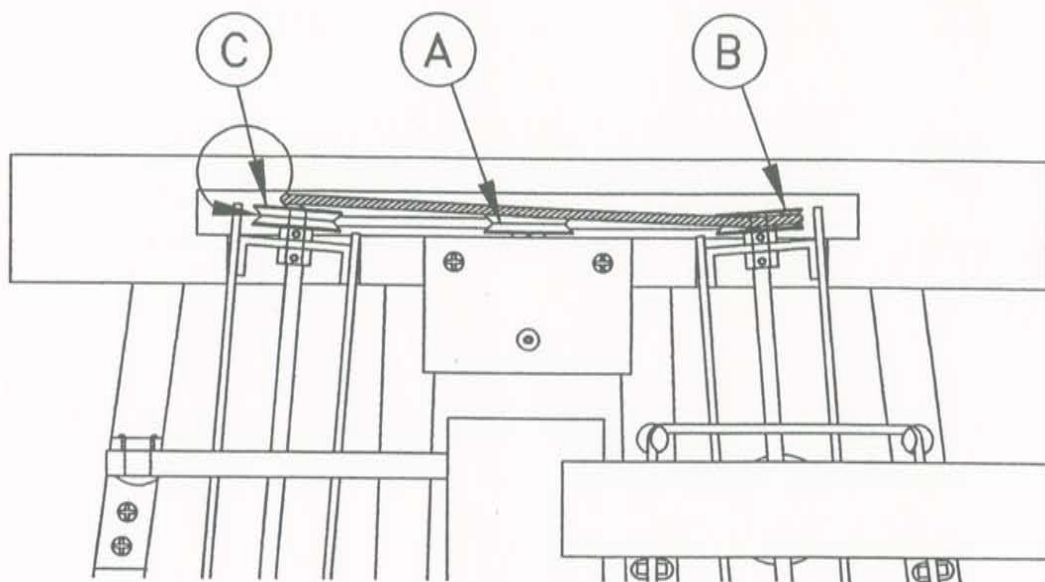

ILLUSTRATION VI

NOTE: It is very important to remember, the Pulsator Discs be set at a 45 degree angle to achieve the most balanced resonance across the entire keyboard. See Illustration VII.

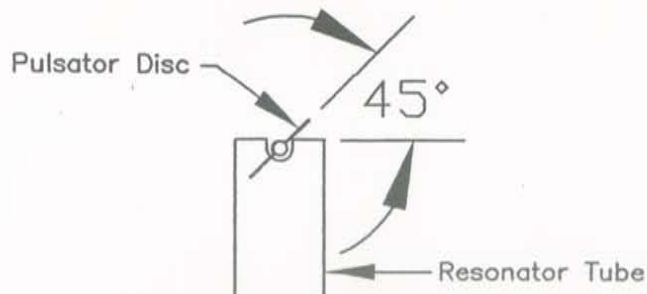

ILLUSTRATION VII

8. Place the Natural Scale Bars on the Instrument and unhook the springs (See Illustration VIII). Place the Bar Cord around the End Posts at the narrow end of the instrument. Start placing the Bars between the Bar Support Posts at the wide end of the instrument and work toward the narrow end until all the Bars are in Place. Hook the springs together. Repeat the same procedure for the Sharp Scale Bars. It may be necessary to lower the Damper Bar (depress the Pedal) in order to align the Bar Cord under the hooked portion of the Posts on the two Center Rails.

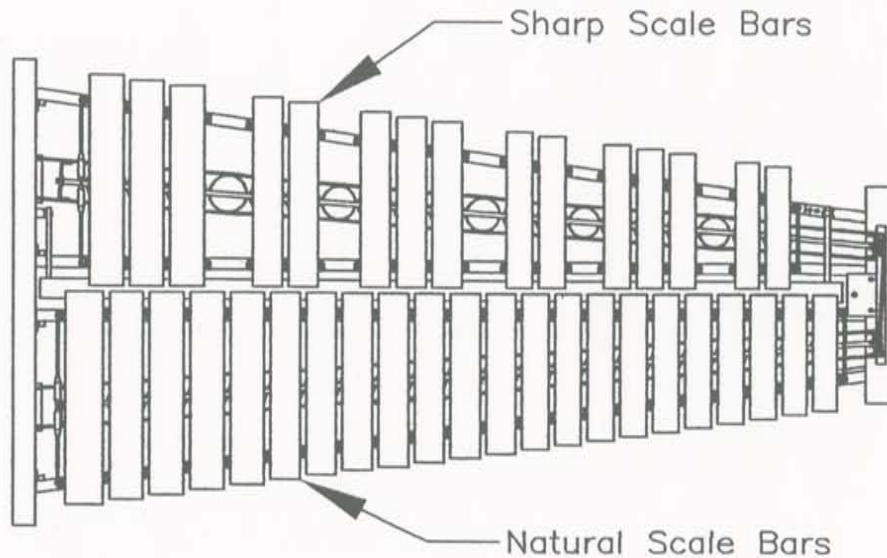
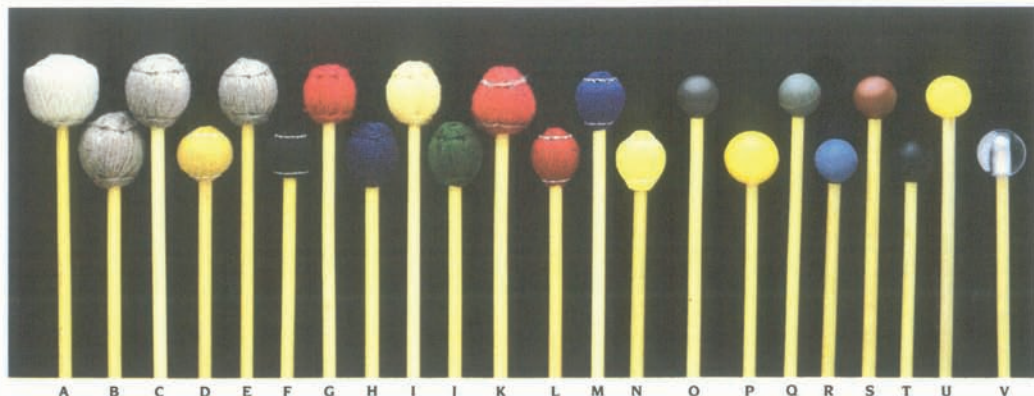

ILLUSTRATION VIII

9. Adjust the Damper Pedal (Shown in Illustration III) to proper playing height, about one inch off the ground. Tighten the Knob securely to prevent the Upper Pull Rod from slipping. The instrument is now ready for use.

Your new instrument is guaranteed against defects in workmanship and material through normal use. Please use good judgement in selecting your mallets. Use of brass or steel ball mallets will nullify the guarantee. Do not use Acrylic or Lexan mallets on wood keyboards.



Rattan Handle Mallets

These high quality mallets feature select rattan handles. Rubber heads are hardness-graduated for a wide selection of tonal responses. Finest grade cord or yarn is used on covered mallets. Each mallet is carefully matched and balanced for flex, weight, and size. Packed in clear-view vinyl cases. The professional Gary Burton Signature Mallets (M-220, M-221) are crafted to his personal specifications.

Description	Model No.	Description	Model No.
A. Yarn 1 1/8", Very Soft, Natural (M)	M-204	N. Cord 1", Soft, Yellow (V)	M-218
B. Yarn 1 1/8", Very Soft, Gray (M)	M-223	O. Phenolic 1", Hard, Brown (B, X)	M-215
C. Yarn 1 1/8", Soft, Gray (M)	M-210	P. Rubber 1 1/8", Medium Soft, Yellow (M)	M-205
D. Yarn 1 1/8", Medium Hard, Gold (M, V)	M-221	Q. Rubber 1", Hard, Gray (B, X)	M-214
E. Yarn 1 1/8", Soft, Gray (M)	M-209	R. Rubber 1", Medium Hard, Blue (M, B, X)	M-213
F. Yarn 1 1/8", Soft, Black (M, V)	M-220	S. Rubber 1", Medium, Red (M, X)	M-212
G. Yarn 1", Hard, Red (M)	M-206	T. Rubber 1", Medium Soft, Black (M)	M-224
H. Yarn 1", Medium, Blue (M, V)	M-207	U. Rubber 1", Soft, Yellow (M)	M-211
I. Yarn 1", Medium Soft, Yellow (M)	M-208	V. Lexan 1 1/8", Very Hard, Clear (B, X)	M-203
J. Yarn 1", Soft, Green (M)	M-222		
K. Yarn 1", Soft, Red (M)	M-219		
L. Cord 1", Hard, Red (V, X)	M-216		
M. Cord 1", Medium, Blue (V)	M-217		

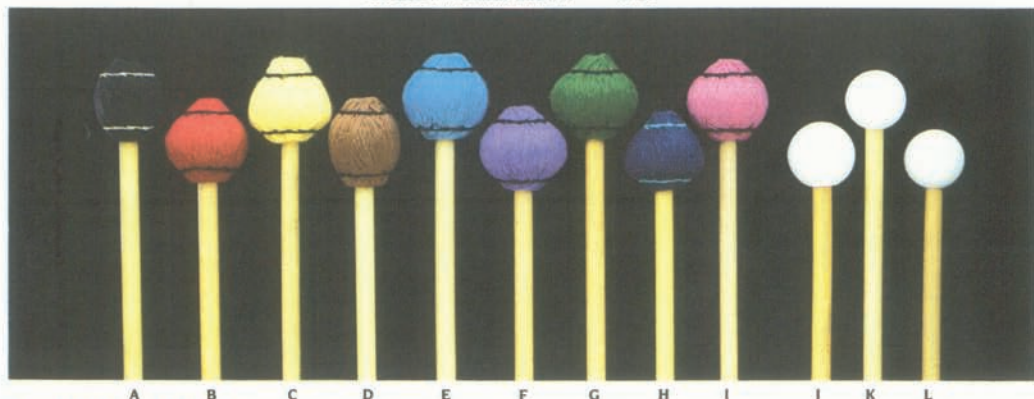

Good Vibes Mallets

Good Vibes are recognized as the world's finest professional mallets. Handles are choice light rattan, carefully selected and matched for size, weight, and flex. Select premium yarn is wound around a solid, specially formulated and shaped rubber core, then carefully hand-stitched. Packed in clear-view vinyl cases.

Description	Model No.	Description	Model No.
A. Yarn 1 1/8", Hard, Black (X)	M-232	G. Yarn 1 1/8", Medium Hard, Green (V)	M-239
B. Yarn 1 1/8", Hard, Red (V)	M-236	H. Yarn 1 1/8", Medium Soft, Navy Blue (M, V)	M-228
C. Yarn 1 1/8", Medium Hard, Yellow (M, V)	M-229	I. Yarn 1 1/8", Medium Soft, Pink (V)	M-233
D. Yarn 1 1/8", Medium Hard, Brown (X)	M-231	J. Poly 1 1/8", Medium Hard, White (B, X)	M-226
E. Yarn 1 1/8", Medium Hard, Royal Blue (V)	M-235	K. Poly 1", Medium Hard, White (B, X)	M-225
F. Yarn 1 1/8", Medium Hard, Violet (V)	M-237	L. Nylon 1", Hard, White (B, X)	M-227

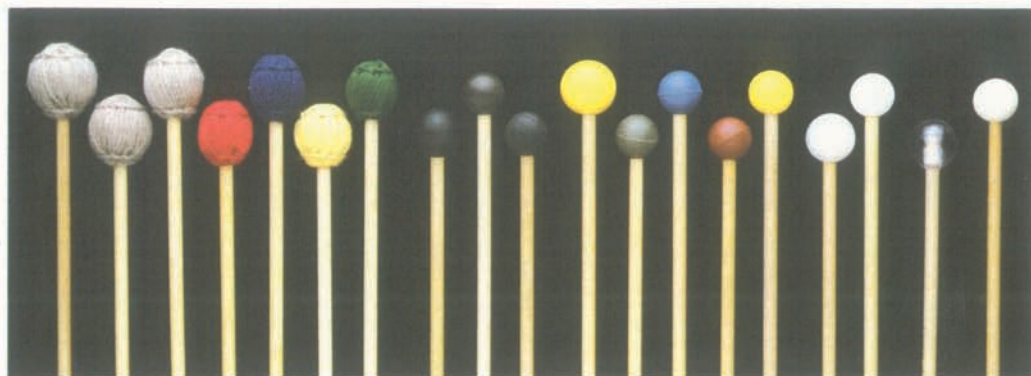

A B C D E F G H I J K L M N O P Q R S

Birch Handle Mallets

For the mallet player who wants a straight, but firmer, wood handle mallet. Precision matched for balance, these mallets come with rubber, plastic, or yarn heads. Packaged in clear vinyl cases.

Description	Model No.		Model No.
A. Yarn 1 1/8". Very Soft, Gray (M)	M-412	K. Rubber 1 1/2", Medium Soft, Yellow (M)	M-413
B. Yarn 1 1/2", Soft, Gray (M)	M-410	L. Rubber 1", Hard, Gray (B, X)	M-404
C. Yarn 1 1/8", Soft, Gray (M)	M-409	M. Rubber 1", Medium Hard, Blue (M, B, X)	M-403
D. Yarn 1", Hard, Red (M)	M-406	N. Rubber 1", Medium, Red (M, X)	M-402
E. Yarn 1", Medium, Blue (M, V)	M-407	O. Rubber 1", Soft, Yellow (M)	M-401
F. Yarn 1", Medium Soft, Yellow (M)	M-408	P. Poly 1 1/8", Medium Hard, White (B, X)	M-4226
G. Yarn 1", Soft, Green (M)	M-411	Q. Poly 1", Medium Hard, White (B, X)	M-4225
H. Phenolic 1 1/8", Hard, Black (B, X)	M-424	R. Lexan 1 1/8", Very Hard, Clear (B, X)	M-423
I. Phenolic 1", Hard, Brown (B, X)	M-405	S. Nylon 1", Hard, White (B, X)	M-4227
J. Phenolic 1", Hard, Black (B, X)	M-428		

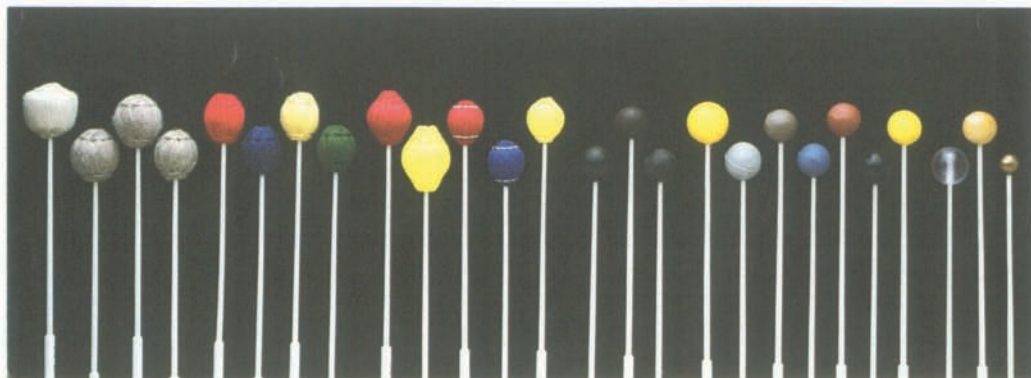

A B C D E F G H I J K L M N O P Q R S T U V W X Y Z

Two-Step Handle Mallets

Musser's exclusive two-step fiber-glass handles are thick near the end for well-balanced handling and thin near the head for strong striking force. Excellent flexibility, yet highly warp resistant. All mallets precision matched for balance. Available in a wide variety of graduated rubber, plastic, metal, and wood balls as well as cord or yarn-covered balls. Packaged in clear vinyl cases.

Description	Model No.		Model No.
A. Yarn 1 3/8", Soft, Natural (M)	M-19	P. Phenolic 1", Hard, Black (B, X)	M-28
B. Yarn 1 3/8", Very Soft, Gray (M)	M-12	Q. Rubber 1 1/2", Medium Soft, Yellow (M)	M-13
C. Yarn 1 1/2", Soft, Gray (M)	M-10	R. Rubber 1 1/8", Hard, Gray (B, X)	M-22
D. Yarn 1 1/8", Soft, Gray (M)	M-9	S. Rubber 1", Hard, Gray (B, X)	M-4
E. Yarn 1", Hard, Red (M)	M-6	T. Rubber 1", Medium Hard, Blue (M, B, X)	M-3
F. Yarn 1", Medium, Blue (M, V)	M-7	U. Rubber 1", Medium, Red (M, X)	M-2
G. Yarn 1", Medium Soft, Yellow (M)	M-8	V. Rubber 1", Medium Soft, Black (M)	M-25
H. Yarn 1", Soft, Green (M)	M-11	W. Rubber 1", Soft, Yellow (M)	M-1
I. Cord 1 1/2", Medium Hard, Red (M, V)	M-27	X. Lexan 1 1/8", Very Hard, Clear (B, X)	M-23
J. Cord 1 1/2", Medium, Yellow (M, V)	M-29	Y. Wood 1", Hard, Maple ()	M-15
K. Cord 1", Hard, Red (V, X)	M-16	Z. Brass 3/8", Very Hard, Gold (Steel Bells)	M-14
L. Cord 1", Medium, Blue (V)	M-17		
M. Cord 1", Soft, Yellow (V)	M-18		
N. Phenolic 1 1/8", Hard, Black (B, X)	M-24		
O. Phenolic 1", Hard, Brown (B, X)	M-5		

USAGE CODE: V = Vibraphone, M = Marimba, X = Xylophone, B = Bells

HOW TO OBTAIN MALLETS, REPLACEMENT PARTS, OR SERVICE

CONTACT YOUR LOCAL LUDWIG/MUSSER AUTHORIZED DEALER. THE DEALER WILL CONTACT OUR DEALER SERVICE DEPARTMENT TO ASSIST YOU.

IF YOU CANNOT LOCATE AN AUTHORIZED DEALER, PLEASE CALL 219-522-1675 AND ASK FOR DEALER SERVICE.

**VISIT OUR LUDWIG/MUSSER
WEB SITE ON THE INTERNET**

<http://www.ludwig-drums.com>

Products

- Drum Outfits
- Snare Drums
- Marching Percussion
- Concert Percussion
- Educational Percussion
- Hardware

Artists/Clinicians

- Drum Outfits
- Marching
- Mallet Instrument
- Total Percussion

Promotional Items

- Catalogs/Brochures
- Posters
- Wearable Items

What's New

- New Product Press Releases
- Percussion Events

Dealers

- USA by State
- Canada by Province
- International Distributors